

CUSTOMER RESPONSIBILITIES

- INSTALLATION OF "Y" AXIS RAILING SYSTEM
- LOCATING & PLACEMENT OF ELECTRICAL PANEL
- ASSEMBLY OF HOSE AND CABLE CARRIER FLEX TRACK SYSTEM
- PROVIDE ELECTRICAL SERVICE & WIRE TERMINATION TO PROVIDED DISCONNECTS
- PROVIDE ALL PLUMBING SERVICES & PLUMBING TO SUPPLY POINT OF MACHINE
- PLUMBING GASES MUST BE LARGE ENOUGH TO SAFELY SUPPORT MAXIMUM MATERIAL PROCESSING
- SUPPLY AND INSTALLATION OF MATERIAL SUPPORT SURFACE
- SUPPLY ADEQUATE & SAFE MATERIAL FIXTURING FOR ENTIRE MATERIAL THICKNESS RANGE & TYPES
- PROVIDE COOLANT FOR DRILLING OPERATION
- SUPPLY ALL TOOLING FOR CUTTING AND DRILLING THAT WILL BE NEEDED FOR STARTUP, TESTING, & TRAINING

NOTE: ALL GAS AND ELECTRICAL INSTALLATIONS MUST BE IN ACCORDANCE WITH STATE & LOCAL CODES

SYSTEM OPTIONS:

- AUTO-GAS OXY-FUEL TORCH SYSTEM
- HPR260 AUTO-GAS PLASMA SYSTEM W/ COMMAND THC
- AUTOMATIC CONTROL 10 HP HIGH SPEED DRILL ASSEMBLY
- ARC WRITER MARKING & LIFTER ASSEMBLY
- EMERGENCY PARTS KIT
- OFFICE SEAT OF CADNESTING PRO WITH TRUE SHAPE NESTING
- WATER TABLE MATERIAL CLAMPING KIT
- DRAWING PACKAGE FOR CUSTOMER FAB WATER TABLE & MATERIAL CLAMP SYSTEM

THE SERVICE PANEL AND PLASMA COMPONENTS ARE TO BE WITHIN 15' FROM THE CENTER OF THE LENGTH AXIS OF TRAVEL.

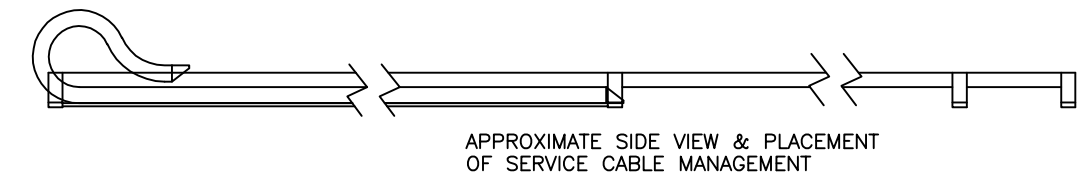
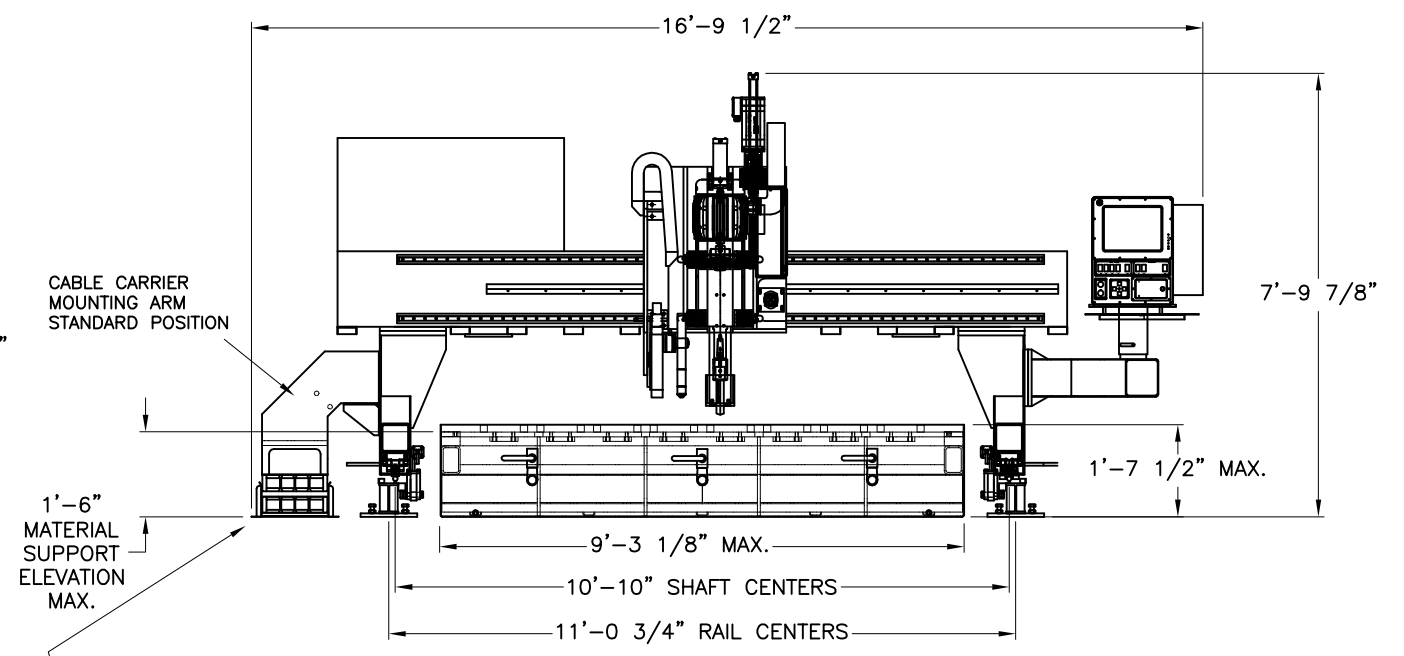
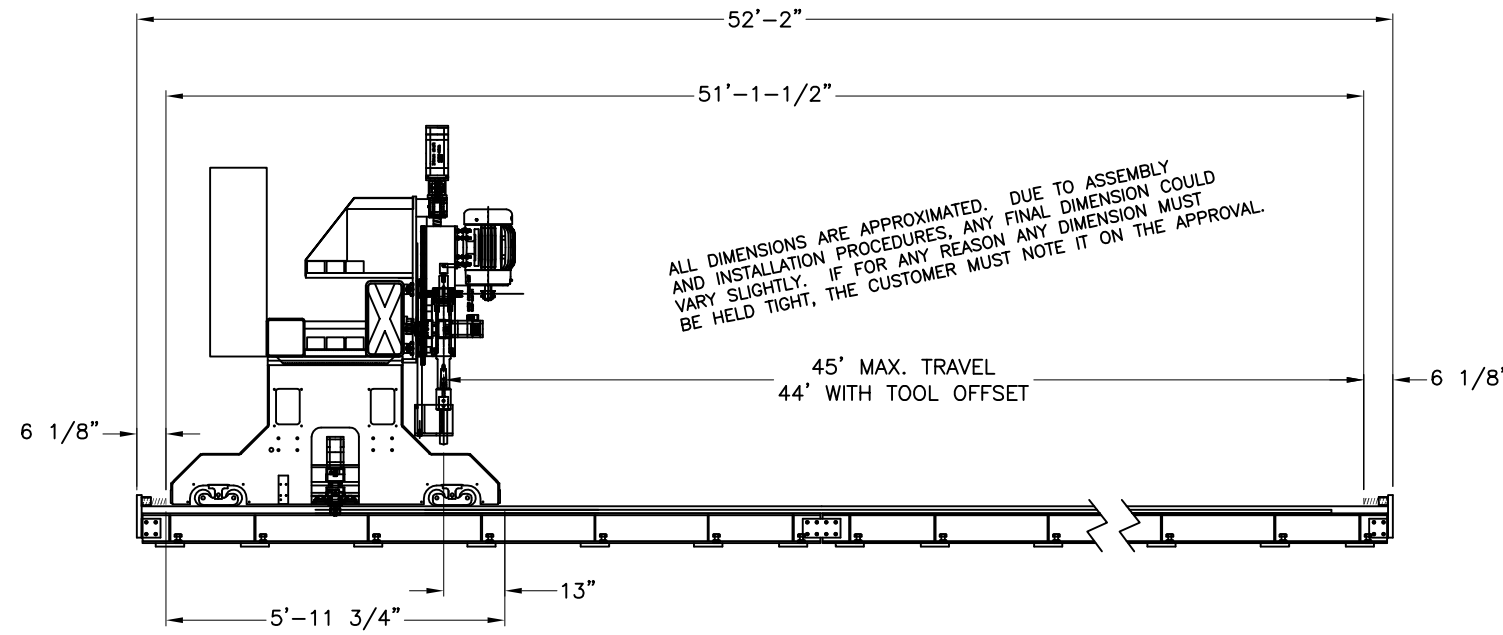
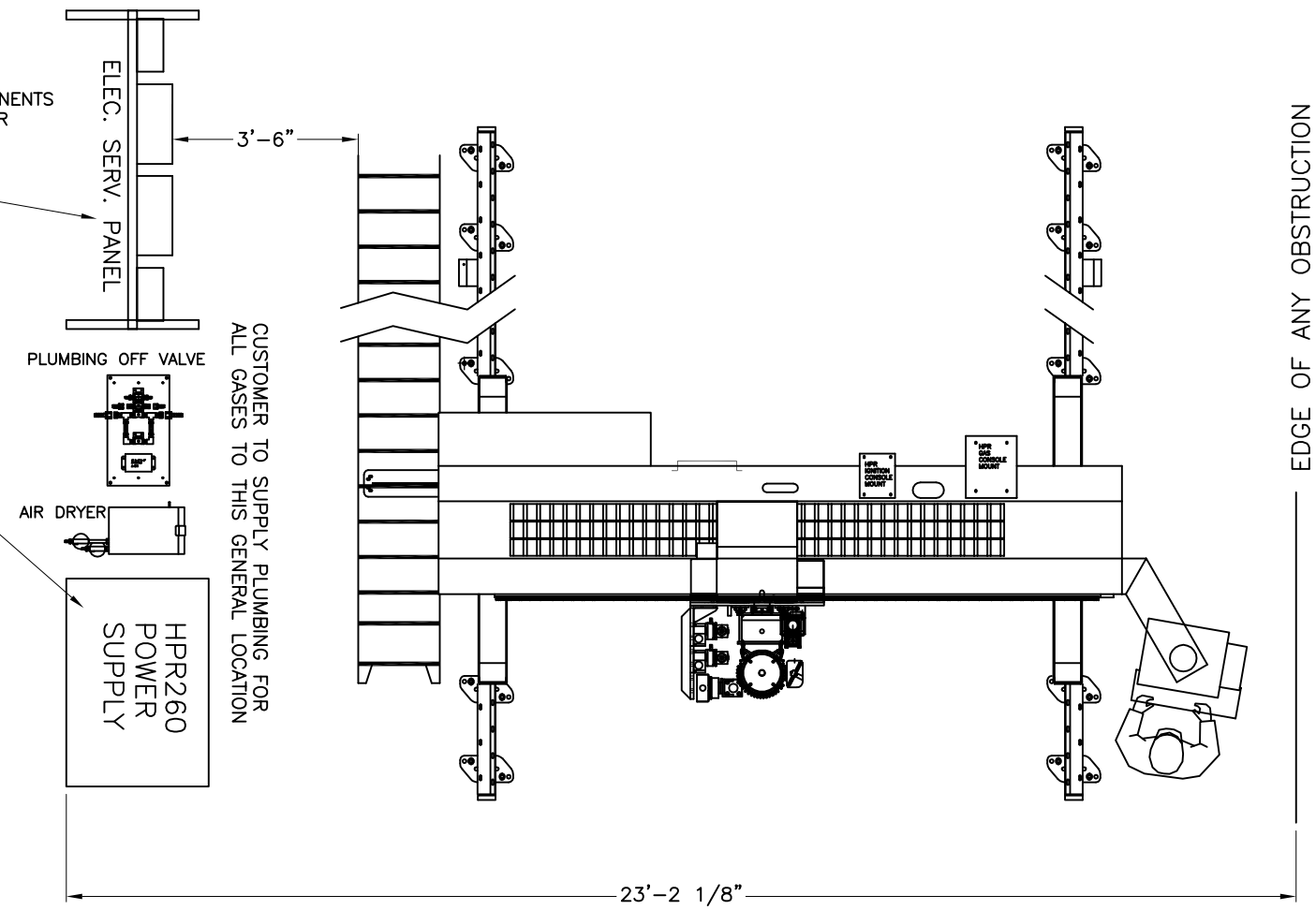

REV	DESCRIPTION	BY	DATE

© CONTROLLED AUTOMATION, INC.
BRYANT, ARKANSAS

TITLE: 8'X44' BTD LAYOUT
General Machine layout

SCALE: NTS	DATE: 4/23/08	JOB NUMBER:
DRAWN BY: JAR	REF. DWG.:	DRAWING NUMBER: REV: