

THE SERVICE PANEL AND PLASMA COMPONENTS ARE TO BE WITHIN 15' FROM THE CENTER OF THE LENGTH AXIS OF TRAVEL.

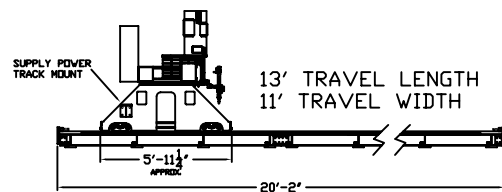

MULTIMAX MACHINES CAN BE MADE:
 WIDER OR NARROWER THAN SHOWN
 WITH MORE OR LESS TRAVEL THAN SHOWN
 OPPOSITE HAND THAN SHOWN
 WITH OR WITHOUT A WORK SURFACE
 WITH WATER TABLES, DOWN DRAFTS, DRY TABLES
 WITH ROLLER CONVEYOR WORK TABLES
 WITH SHUTTLE TABLE CARTS SYSTEMS
 WITH DROSS REMOVAL TABLE SYSTEMS
 WITH MORE OR CLEARANCE THAN SHOWN
 WITH UP TO 4 PLASMA TOOL STATIONS
 WITH UP TO 8 OXY-FUEL STATIONS
 WITH POWER TRACK SYSTEM OVER-HEAD
 WITH TUCKED LENGTH AXIS RAILS
 UNITIZED WITH CUTTING SURFACE
 WITH CUSTOMER SPECIFIC OPTIONS

CUSTOMERS RESPONSIBILITIES

- MOUNTING OF "Y" AXIS RAIL
- INSTALLATION OF ELECTRICAL PANEL
- INSTALLATION OF HOSE AND CABLE CARRIER
- TERMINATION OF ELECTRICAL SERVICE TO ELECTRICAL DISCONNECTS
- TERMINATION OF GAS SUPPLIES TO THE MACHINE & PLASMA SYSTEMS
- SUPPLY AND INSTALLATION OF WATER OR CUTTING TABLE
- SUPPLY PLASMA WITH DESIRED CUTTING & SHIELD GASES
- SUPPLY SHOP AIR AND OXY-FUEL HOISING TO MACHINE THROUGH CABLE CARRIER SYSTEM.
- SUPPLY ALL TOOLING CONSUMABLES FOR START-UP & TRAINING

NOTE:
 ALL GAS AND ELECTRICAL INSTALLATIONS MUST BE IN ACCORDANCE WITH STATE AND LOCAL CODES.

NOTE:
 IT IS THE CUSTOMERS RESPONSIBILITY TO ASSURE THAT THE SUPPLY VOLUMES OF THE OXYGEN & THE FUEL GAS IS LARGE ENOUGH TO SAFELY SUPPORT MAX. CUTTING CAPACITY PER TORCH USED.

ALL DIMENSIONS ARE APPROXIMATED. DUE TO ASSEMBLY TOLERANCES AND INSTALLATION PROCEDURES, ANY FINAL DIMENSIONS COULD VARY SLIGHTLY. IF FOR ANY REASON ANY DIMENSION MUST BE HELD TIGHT, THE CUSTOMER MUST NOTE IT ON THE APPROVAL.

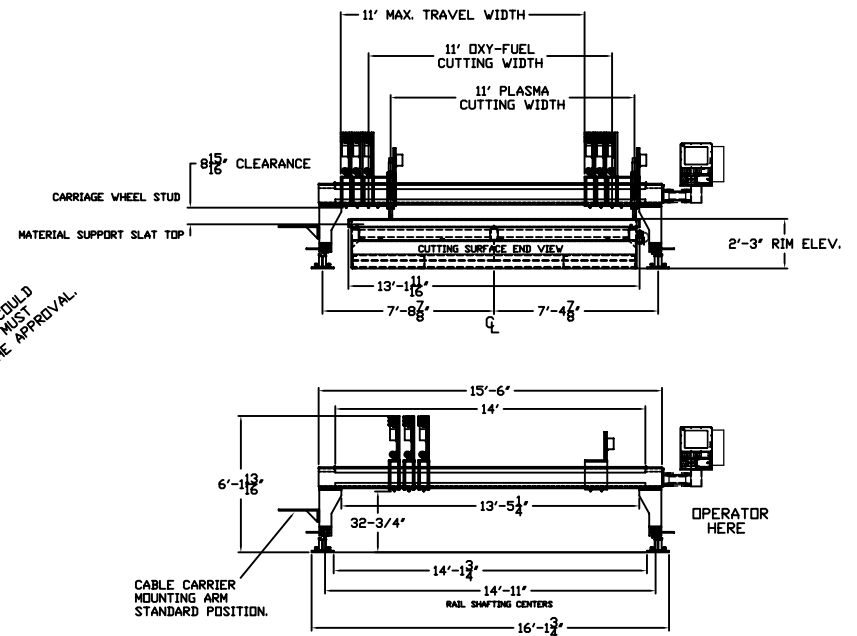

REV	DESCRIPTION	BY	DATE	 CONTROLLED AUTOMATION, INC. BRYANT, ARKANSAS	TITLE: 10' X 13' MULTIMAX MACHINE 3 OXY - 1 PLASMA	SCALE: NTS DRAWN BY: JAR	DATE: 4/30/08 REF. DWG.	JOB NUMBER DRAWING NUMBER	REV.
-----	-------------	----	------	--	---	-----------------------------	----------------------------	------------------------------	------